

Varenummer: 03554025

Beskrivelse: Fluro hydraulik ledhoved FMA 25D

Mål

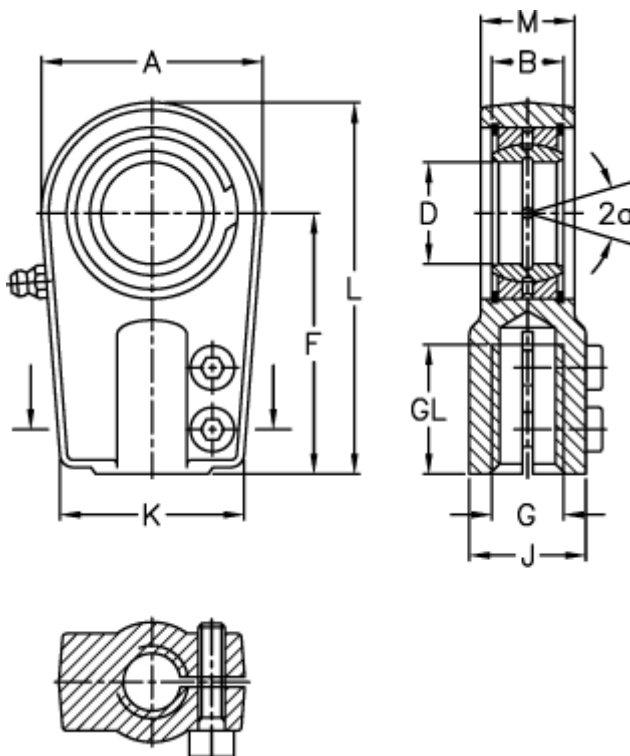

A	= 56	J	= 28
a (grader)	= 8	K	= 48
B	= 20	L	= 95
D	= 25	M	= 23
Dynamisk belastning C (kN)	= 51	Moment (Nm)	= 20
F	= 65	Statisk belastning C0 (kN)	= 66
g	= M18x2	Vægt	= 650
GL	= 30		